

SUPERIOR 1250 MAINTENANCE SHEET - HOW TO ASSEMBLE

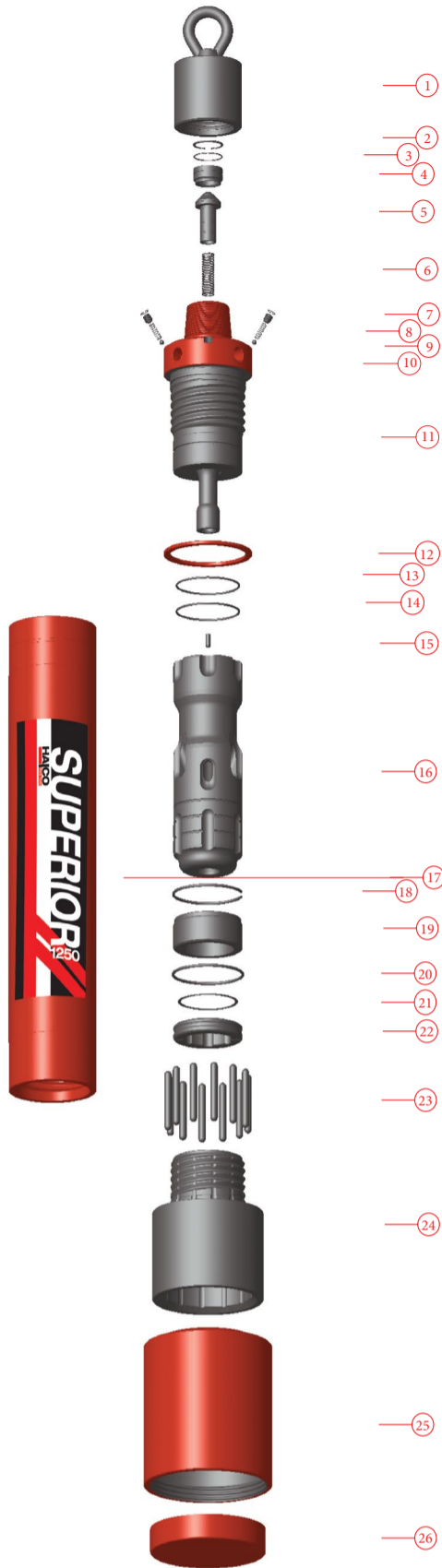

A. Before assembly ensure that all components are cleaned, greased and lubricated. Lay out components in the order of the illustration above for ease of identification.



B. Secure Cylinder (17) on a bench or suitable stripping equipment. The cylinder has two identically positioned snap ring grooves and is reversible.

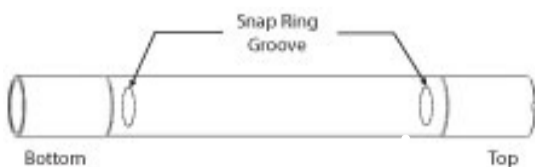

C. Insert Snap Ring (18) into bottom of Cylinder (17). Ensure that it sits in the snap ring groove.

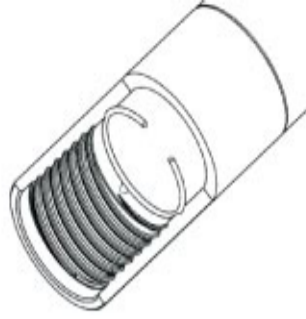

D. Insert Bit Guide Bush (19) into bottom of Cylinder (17). Fit 'O'Ring (20) onto Bit Guide Bush (19). Ensure it sits in the 'O' Ring groove.

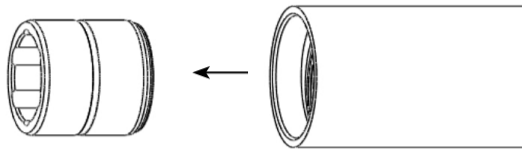

E. Grease splines and Insert Drive Pins (23) between Drill Bit and Chuck (24) splines.

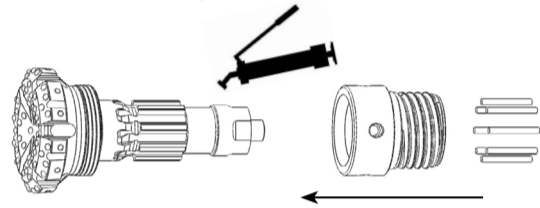

F. Fit Shroud (25) onto Drill Bit.

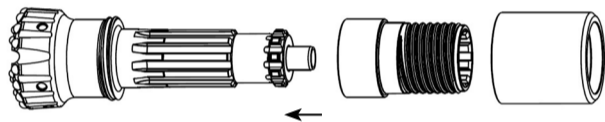

G. Fit 'O'Ring (21) onto Bit Retaining Ring (22). Ensure it sits in the 'O'Ring groove. Fit Bit Retaining Ring (22) onto the Drill Bit.

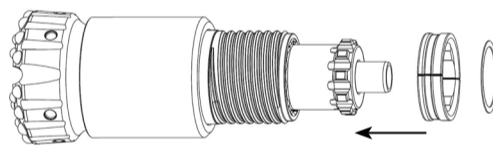

H. Grease threads and screw the Drill Bit, Chuck (24) and Bit Retaining Ring (22) into the bottom of the Cylinder (17) until fully tightened.

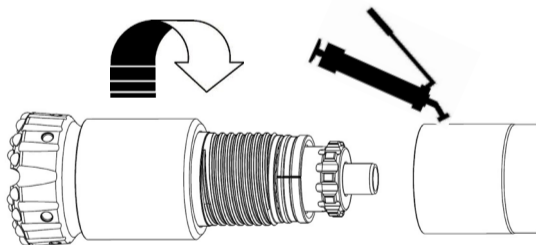

I. Insert Bleed Plug (15) into the top of the Piston (16). Ensure it is pushed fully into the bleed hole.

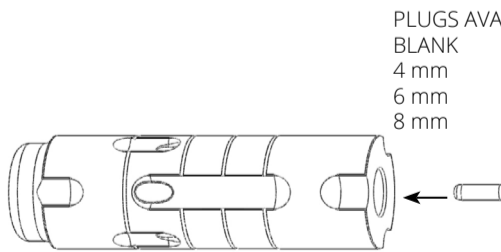

PLUGS AVAILABLE:
BLANK
4 mm
6 mm
8 mm

J. Coat Piston (16) liberally with rock oil - minimum 200 centistroke and insert into the top of the Cylinder (17). Ensure that the Piston is inserted the right way around - as illustrated below.

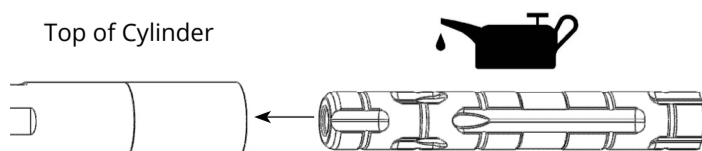

K. Fit 'O' Ring (3) to N.R.V. Seat (4). Ensure it sits in the 'O' Ring groove.

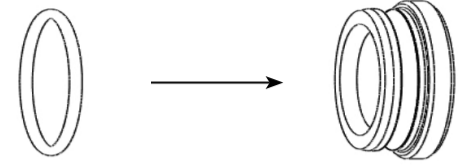

L. Insert N.R.V. Assembly (3-6) into Top Adaptor (11).

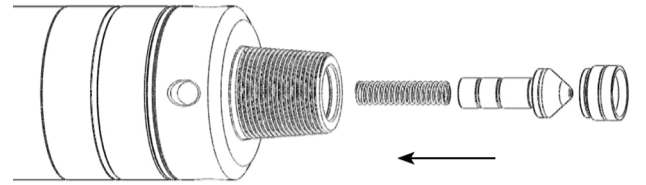

M. Insert Snap Ring (2) into Top Adaptor (11). Ensure it sits in the snap ring groove.

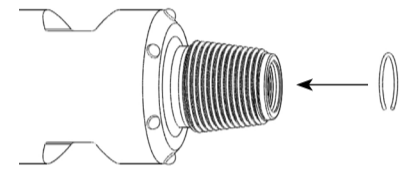

N. Insert Bypass N.R.V. Assembly containing items (7-10) into Top Adaptor (11).

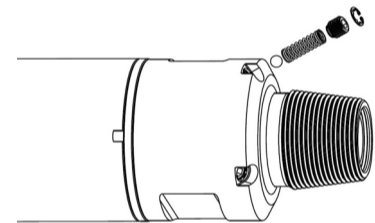

O. Fit 'O'Rings (13 & 14) and Spacer (12) onto Top Adaptor (11). Ensure the 'O'Rings sit in the 'O'Ring groove.

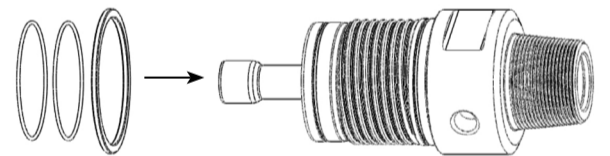

P. Grease threads and screw Top Adaptor (11) into Cylinder (17) until fully tightened.

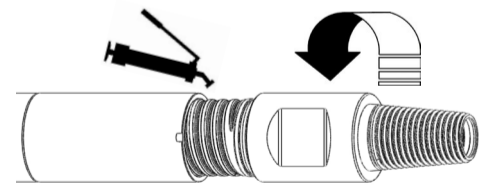

Q. Depress N.R.V (5) and pour 1/3 litre of air line oil into the hammer.

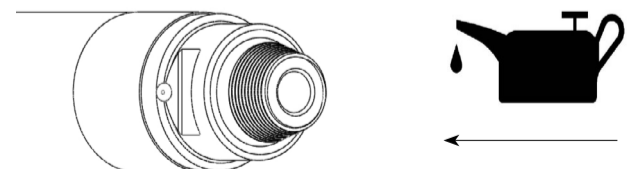

If you need further assistance, please call us on:
(0)1422 399900 or email salesuk@halcorocktools.com

HAJCO
Rock Tools

SUPERIOR 1250 MAINTENANCE SHEET - HOW TO DISMANTLE

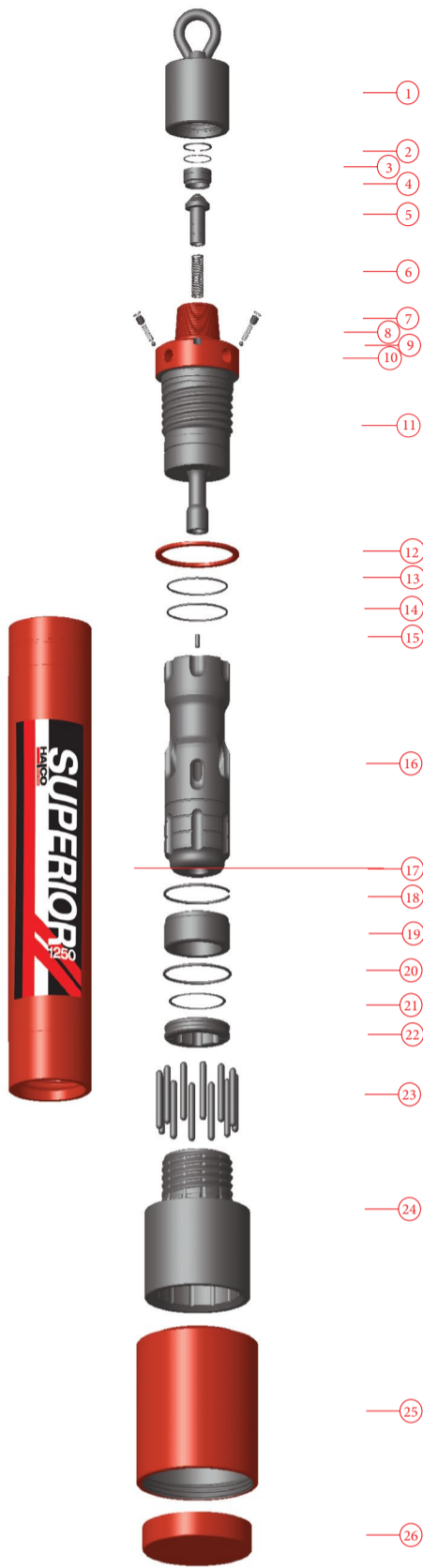

B. Break the top joint between Cylinder (17) and Top Adaptor (11) and bottom joint between Cylinder (17) and Chuck (24).

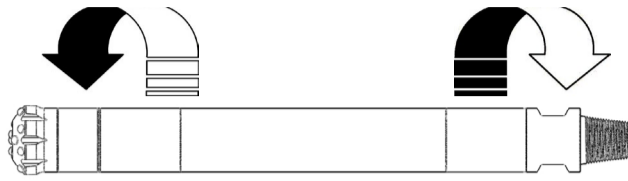

C. Unscrew and remove the Chuck (24) and Shroud (25) from the Cylinder (17).

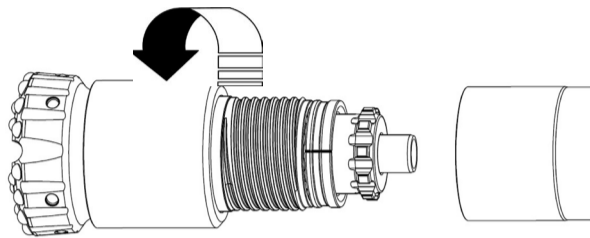

D. Remove the Bit Retaining Ring (22) from the Drill Bit. Then 'O' Ring (21) from Bit Retaining Ring (22).

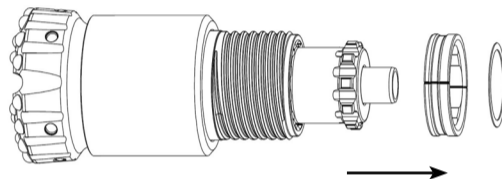

E. Remove Drive Pins (23) from between Drill Bit and Chuck (24) splines.

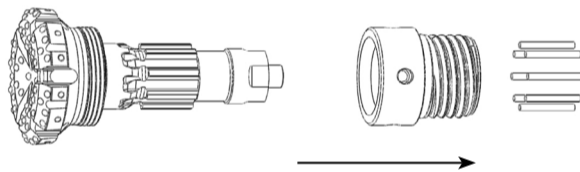

F. Remove the Shroud (25) and the Chuck (24) from Drill Bit.

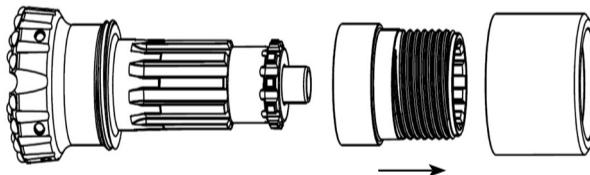

G. Remove Bit Guide Bush (19) from Cylinder (17). Remove 'O' Ring (20) from the Guide Bush (19).

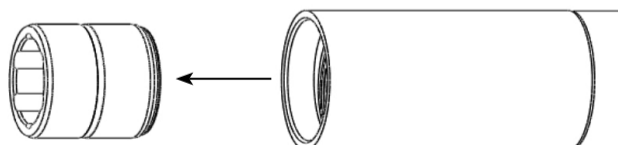

H. Remove Snap Ring (18) from the Cylinder (17) using the tools illustrated below.

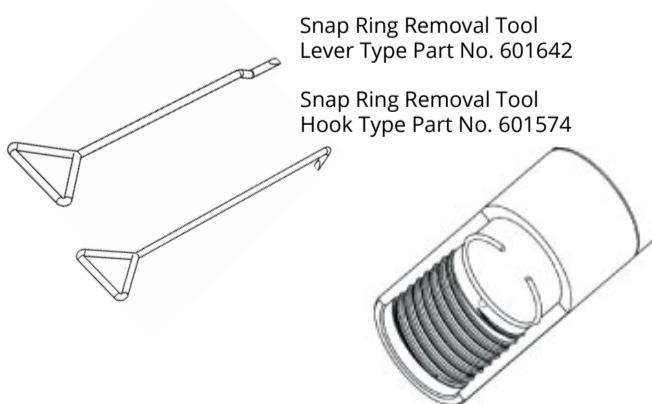

I. Remove Piston (16) from Cylinder (17).

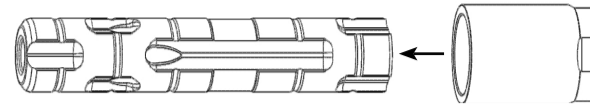

J. Remove Snap Ring (2) from Top Adaptor (11).

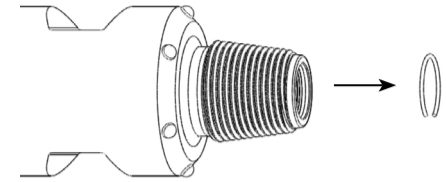

K. Remove N.R.V. Assembly (3-6) from Top Adaptor (11).

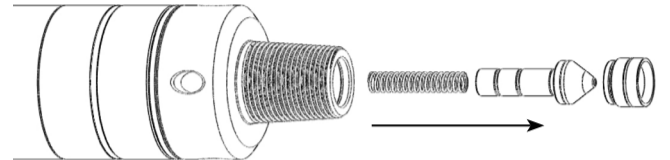

L. Remove 'O' Ring (3) to N.R.V. Seat (4). Ensure it sits in the 'O' Ring groove.



M. Remove Bypass N.R.V. Assembly (7-10) from Top Adaptor (11).

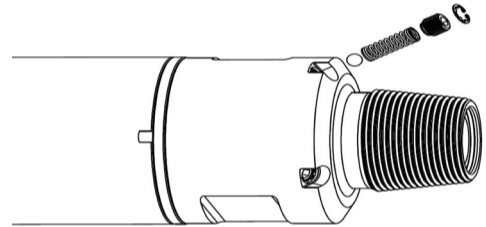

N. Unscrew and remove Top Adaptor (11) from the Cylinder (17).

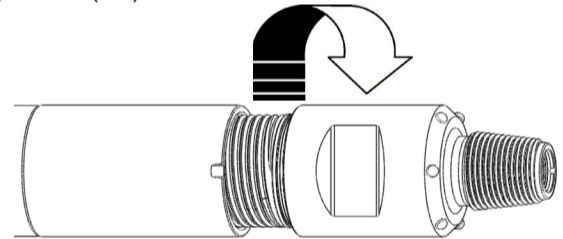

O. Remove 'O' Rings (13 & 14) and Spacer (12) from Top Adaptor (11).

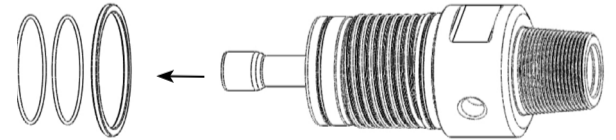

DO NOT apply heat or direct impact to the outside of the hammer as this usually damages the equipment.



A. When dismantling hammers it is essential that cylinders are clamped into the correct position, away from threads, which can be damaged.



X & Y = DO NOT CLAMP HERE
X = 441 mm (17.362")
Y = 520 mm (20.472")

If you need further assistance, please call us on:
(0)1422 399900 or email salesuk@halcorocktools.com

HAJCO
Rock Tools